



Z-CAM

All Original Numbers, Marks and Models from
Vehicle Manufacturers Listed in this catalogue
are for comparison purposes only



www.brakingtech.com



BTG01001

Description :

Grease Oil(White)

Application : :

Content is 5gr.For metal&rubber items in Airbrake system

OEM No :

1114525, 1132868, K93430, 1132793, S-29152-12



BTZ60001

Description :

Return Spring

| No | BT No | Information |
|----|------------|---------------|
| 1 | BTT251 x 1 | Return Spring |

Application : :

FORD,DAF,DENNIS,ERF,RENAULT,VOLVO,BMC,RAI

OEM No :

167090, 68192115, 9C462296AA, 665153,
 1892003407951, 1398023, 8607130, 1694362,
 1696444, 3097092, 5006 018 480, 3346437R1,
 9P901265, 61385919, 65399619, 29000000088,
 5001 868 113



BTZ60002

Description :

Return Spring Pin

| No | BT No | Information |
|----|------------|-------------------|
| 1 | BTT252 x 1 | Return Spring Pin |

Application : :

VOLVO,RABA,FORD,BMC

OEM No :

368192487, 0972299, 1698346, 9C462069AA,
 3097299, 1696445, 137075, 68200150



BTZ60003

Description :

Adjusting Pinion(L/H)

| No | BT No | Information |
|----|------------|------------------|
| 1 | BTT253 x 1 | Adjusting Pinion |

Application : :

VOLVO,RENAULT,MAN

OEM No :

3090997, 1081819, ST1038, 68020145, 1606775,
 5006 046 765, 1428741

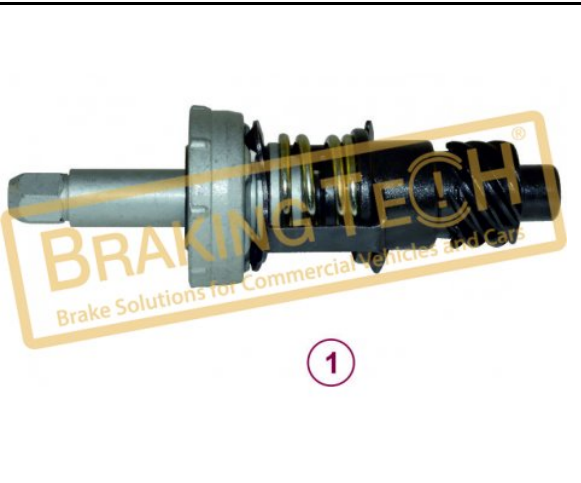

BTZ60004

Description :
 Adjusting Pinion(R/H)

Application :
 VOLVO,RENAULT,MAN

OEM No :
 3090998, 1081820, ST1039, 68020146, 1607502,
 5006 046 766, 1428758, N2509996051

| No | BT No | Information |
|----|------------|------------------|
| 1 | BTT254 x 1 | Adjusting Pinion |



BTZ60005

Description :
 Cross Shaft

Application :
 MAN,MB,AWD,DAF,Ford,Iveco,RENAULT,Dennis

OEM No :
 68191219, 272910, 5001868121, 9C462458AA,
 SP8540, ST4018, 8603403, N2509996050,
 1696453, 3098271, 5006 018 458, 65399621,
 1892003407351, 1422829, 1694368, 5001 868 121,
 3346443R91, 6138597, A4027696

| No | BT No | Information |
|----|------------|-------------|
| 1 | BTT255 x 1 | Cross Shaft |



BTZ60006

Description :
 Thrust Pin

Application :
 VOLVO,RENAULT,FORD,RABA,DENNIS,DAF,MAN,IV

OEM No :
 137074, 64225252, N2970060001, 5006 018 440,
 60889335, 61049727, AAU6457, 1696446,
 6138599, 1694355, 5001 868 120, 16352S1,
 1892003407251, 665152, 9C462B003AA,
 8603393

| No | BT No | Information |
|----|------------|-------------|
| 1 | BTT256 x 1 | Thrust Pin |



BTZ60007

Description :
 Brake Adjusting Gear (Right)

Application :
 MB,VOLVO,RENAULT,DAF,MAN,LEYLAND,BMC,DEI

OEM No :
 68192566, 272908, 3097100, 8550977,
 9C462A105BA, ST4013, ST4024, A164062, MAN
 1472809, 8603390, N2509996054, 5006 018
 437, 65399612, XBU0911, PPMST4013, 61385911,
 9P910414, 3348784R91, 1892003407221,
 3098277, 5001 868 117, 1694353

| No | BT No | Information |
|----|------------|----------------|
| 1 | BTT257 x 1 | Adjusting Gear |



BTZ60008

Description :
 Brake Adjusting Shaft(Left)

Application :
 MB,VOLVO,RENAULT,DAF,MAN,LEYLAND,BMC,DEI

OEM No :
 68162565, 272909, 3097099, 8550978,
 9C462A105AA, ST4014, ST4023, A164061,
 68192565, N2509996057, 5006 018 438,
 3348783R91, 65399613, ZF 0501210719,
 1892003407231, 8603391, 9P911107, 1494055,
 1694352, XBU0910, 665135, 3346429R91,
 61385913, 3098276, PPMST4014, 5001 868 118

| No | BT No | Information |
|----|------------|----------------|
| 1 | BTT258 x 1 | Adjusting Gear |



BTZ60009

Description :
 Brake Adjusting Shaft Cover

Application :
 VOLVO,RENAULT,IVECO,DENNIS,MAN,DAF,MB

OEM No :
 SerinFren

| No | BT No | Information |
|----|-----------|-------------|
| 1 | BTS85 x 1 | Gear Cap |
| 2 | BTK91 x 1 | O-ring |



BTZ60010

Description :
 Lock Cap Repair Kit (Thick Thread-14 Thread)

Application :
 VOLVO F10,MAN

OEM No :
 276099, 85.50001.3424, 8604735, 2068777,
 ST1034

| No | BT No | Information |
|----|------------|-------------------------------|
| 1 | BTK90 x 1 | O-Ring |
| 2 | BTT259 x 1 | oem:68191930-5006018450 |
| 3 | BTK91 x 1 | O-Ring |
| 4 | BTT268 x 1 | Cap (Thick Thread) 14 Tee ... |
| 5 | BTK92 x 1 | O-Ring |



BTZ60011

Description :
 Lock Cap Repair Kit (Thin Thread)

Application :
 MAN,DAF,PACCAR,DENNIS,IVECO,RENAULT,VOLV

OEM No :
 ST1035, ST4022, ZF 0501210721, 8701361,
 N2509996037, 3090964, 3098275,
 3346439R91, AWD A4027698, 65399615,
 TP02006093, 1694364, 61385915, 276100,
 42540290, 7403 090 964, 1341829

| No | BT No | Information |
|----|------------|-------------------------------|
| 1 | BTK90 x 1 | |
| 2 | BTT259 x 1 | Pin oem:68191930-50060184 ... |
| 3 | BTK91 x 1 | |
| 4 | BTT260 x 1 | Cap (Thin Thread) 23 Teet ... |
| 5 | BTK92 x 1 | |

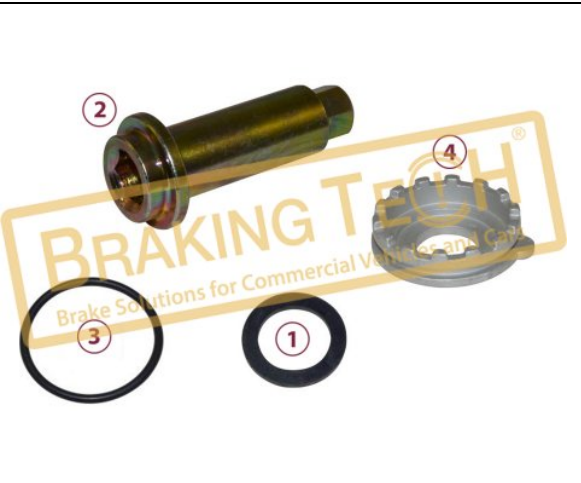

BTZ60012

Description :
Lock Cap Repair Kit (14 Teeth)

Application :
VOLVO,MAN,PACCAR

OEM No :
276096, ST1033, TP02006268, 1449350

| No | BT No | Information |
|----|------------|-------------------------------|
| 1 | BTK93 x 1 | O-Ring |
| 2 | BTT261 x 1 | Pin |
| 3 | BTK94 x 1 | O-Ring |
| 4 | BTT262 x 1 | Cap (Without Tube) 14 Tee ... |

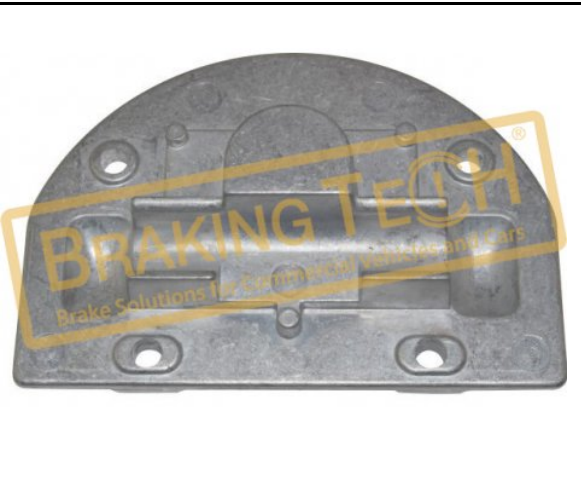

BTZ60013

Description :
Z-Cam Cover

Application :
MAN,DAF,BMC,DENNIS,RABA,IVECO,RENAULT,FO

OEM No :
1696449, 166062, 68191065, 5001 868 127,
3346423R1, 9C462213AA, 665145, 653996-7,
1694347, N2900000084, 5006 018 435,
A4027680

| No | BT No | Information |
|----|------------|-------------|
| 1 | BTT263 x 1 | Cover |

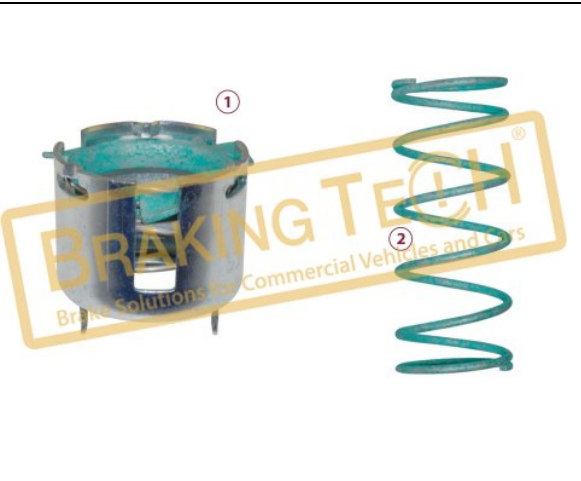

BTZ60014

Description :
Reverse Lock Repair Kit (Right)

Application :
MB,VOLVO,IVECO,FORD,DENNIS,RENAULT,BMC,D/

OEM No :
ST1037, ST4020, 68191541, 1892003407911,
8604737, N2509996047, 3098273, AWD
A4027699, 6539973, 6138604, 9C462K400BA,
9P910412, 1694366, 276098, 7400 276 098,
3346441R91, 1386099

| No | BT No | Information |
|----|------------|----------------|
| 1 | BTSI43 x 1 | Locking Shim |
| 2 | BTY30 x 1 | Locking Spring |

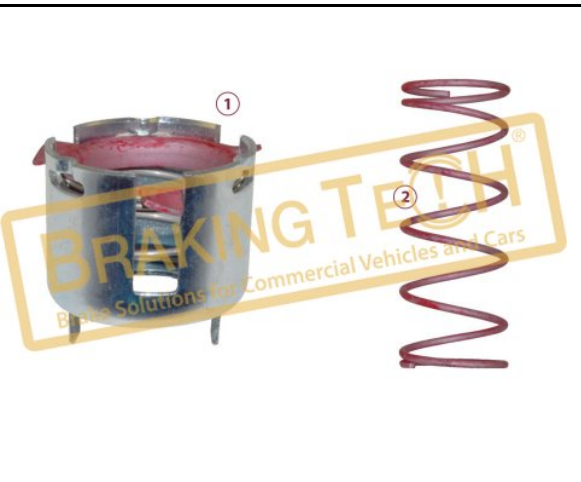

BTZ60015

Description :
Reverse Lock Repair Kit (Left)

Application :
MB,VOLVO,IVECO,FORD,DENNIS,RENAULT,BMC,D/

OEM No :
ST1036, ST4021, PACCAR TP02006094,
68191540, 8604736, N2509996035, 65399617,
9C462K400AA, 61385928, 9P910411, A4027706,
7400 276 097, 3346440R91, 276097, 1694365,
1336762

| No | BT No | Information |
|----|---------------|----------------|
| 1 | BTSI43-01 x 1 | Locking Shim |
| 2 | BTY29 x 1 | Locking Spring |



BTZ60016

Description :
Brake Adjuster Dust Excluder

Application :
RENAULT,VOLVO,IVECO,FORD,RABA,PACCAR,DAF

OEM No :
68192410, ZF 0501316391, 8701359,
N2509990143, 3090954, 5006 018 439,
3346430R91, AWD A4027686, 65399614 ,
65399620, 89200340815, 9C462B009AA,
1427340, 1694354, 5001 868 119, 1696448,
TP08023002, 42540274, 665151, 61385910

| No | BT No | Information |
|----|----------|------------------------|
| 1 | BTK95 x1 | Dust Cover 36x68x20,40 |

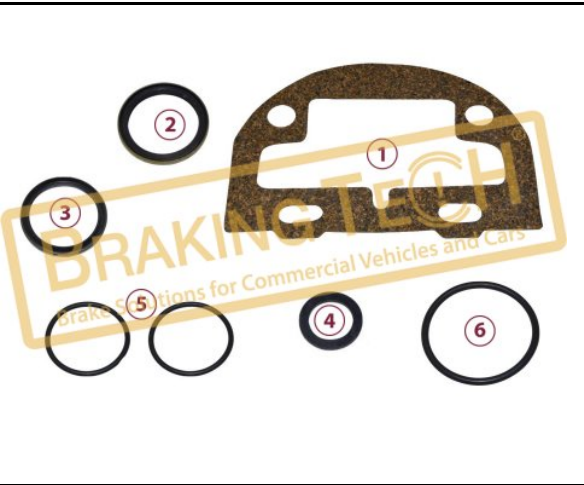

BTZ60017

Description :
Brake Cover Plate Seal Kit

Application :
MAN,AWD,DENNIS,BMC,DAF,RENAULT,VOLVO

OEM No :
272905, ST4025, ST1053, 8701362, 5006 018 459,
3098290, 9P905487, A4027695, 613859-23,
1694370, 653563-8, 1422835, N2965026017

| No | BT No | Information |
|----|----------|-------------------------|
| 1 | BTCN4 x1 | Gasket |
| 2 | BTK89 x1 | Seal 38x47,68x4,80/5,70 |
| 3 | BTK96 x1 | Seal 38x47,68x4,80 |
| 4 | BTK97 x1 | O-Ring |
| 5 | BTK98 x2 | O-Ring |
| 6 | BTK99 x1 | O-Ring |



BTZ60018

Description :
Pinion (Right) (New Model)

Application :
RVI,VOLVO,LEYLAND
DAF,PACCAR,FORD,MAN,MB,IVECO

OEM No :
A164055, 68191511, 1892003407941, 8605967,
N2509990131, 3346449R1, AWD A4027691,
6539963, 6539975, 1696925, 89200340794,
TP02006096, 9C462K161AA, 3346447R1,
6138606, XBU0685, 5001 868 126, 1350890,
1694794

| No | BT No | Information |
|----|-----------|-------------|
| 1 | BTT264 x1 | Pinion |

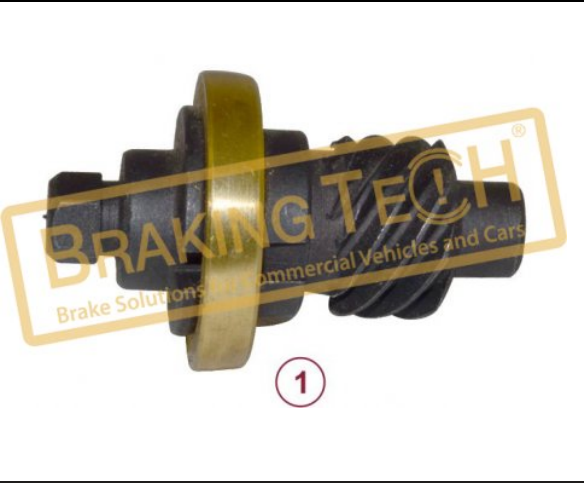

BTZ60019

Description :
Pinion (Left) (New Model)

Application :
RVI,VOLVO,LEYLAND
DAF,PACCAR,FORD,MAN,MB,IVECO

OEM No :
A164052, 68191510, 1892003407931, 8605966,
N2509990129, 5001868125, 5006 018 474, AWD
A4027705, 65399625, 1696924, 89200340793,
9C462K161BA, 3346448R1, XBU0684, 61385929,
1350884, 1694793, 5001 868 125, TP02006095

| No | BT No | Information |
|----|-----------|-------------|
| 1 | BTT265 x1 | Pinion |



BTZ60020

Description :
 Pinion (Left) (Old Model)

Application : :
 Meritor,FORD,RVI

OEM No :
 68191511, 1696925, 5001868125, 9C462K161AA

| No | BT No | Information |
|----|-----------|-------------|
| 1 | BTT266 x1 | Pinion |



BTZ60021

Description :
 Pinion (Right) (Old Model)

Application : :
 Meritor,FORD,RVI

OEM No :
 68191510, 1696924, 9C462K161BA

| No | BT No | Information |
|----|-----------|-------------|
| 1 | BTT267 x1 | Pinion |



BTZ60022

Description :
 Brake Cover Plate Gasket

Application : :
 VOLVO,RENAULT,LEYLAND
 DAF,FORD,MAN,DENNIS

OEM No :
 1696450, 166063, 5001 868 122, 9C462B032AA,
 XBU0889, 653996-8, 1694348, 1321234,
 8603385, N2966010119, 5006 018 436, 613859-4,
 653563-15

| No | BT No | Information |
|----|----------|-------------|
| 1 | BTCN4 x1 | Gasket |

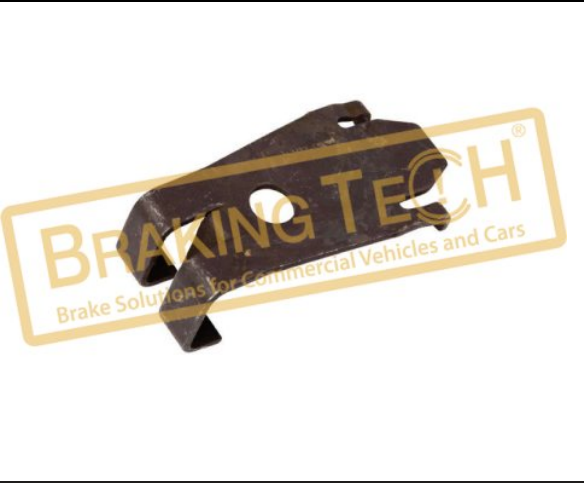

BTZ60023

Description :
 Spring Holder

Application : :
 VOLVO,RENAULT,LEYLAND DAF,FORD,MAN

OEM No :
 5001 868 128, 681 92 612

| No | BT No | Information |
|----|-----------|---------------------|
| 1 | BTT226 x1 | Metal Shield Holder |



BTZ60024

Description :
 Bushing Sac

Application :
 Volvo BUS,RENAULT,LEYLAND DAF,FORD

OEM No :
 1517531, 5001 868 163, 681 91 518, 1088812

| No | BT No | Information |
|----|-----------|---------------------|
| 1 | BTB39 x 1 | Bushing 38X43X26 MM |



BTZ60025

Description :
 Seal Sac

Application :
 VOLVO,RENAULT,LEYLAND DAF,FORD,MAN

OEM No :
 5001 868 162, 682 00 114

| No | BT No | Information |
|----|------------|-------------|
| 1 | BTK155 x 1 | Seal |



BTZ60026

Description :
 Brake Adjusting Gear Cap Set

Application :
 MB,DAF,MAN,VOLVO,IVECO,RENAULT,DENNIS,AW

OEM No :
 272904, 3098272, SP7984, ST4019,
 89200340751, 1892003407511, 1376916,
 N2900006011, 1694367, 5006 018 457,
 3346442R91, A4027697, 61385912, 65399616

| No | BT No | Information |
|----|-----------|-------------|
| 1 | BTS85 x 2 | Gear Cap |
| 2 | BTK91 x 2 | O-Ring |

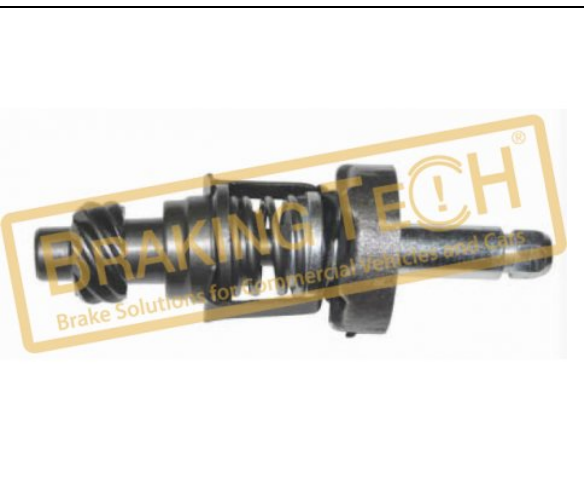

BTZ60027

Description :
 Brake Adjustment old (R/H)

Application :
 Meritor,VOLVO,RENAULT

OEM No :
 1607502, 68020146, 5006 046 766

| No | BT No | Information |
|----|---------------|-----------------|
| 1 | BTT254-01 x 1 | Adjuster Pinion |



BTZ60028

Description :
 Brake Adjustment old (L/H)

| No | BT No | Information |
|----|---------------|-----------------|
| 1 | BTT253-01 x 1 | Adjuster Pinion |

Application :
 Meritor,VOLVO,RENAULT

OEM No :
 1606775, 68020145, 5006 046 765



BTZ60029

Description :
 Brake Bracket Volvo(R/H)

Application :
 Meritor(Ø410),VOLVO FH12

OEM No :
 3092466, 681 92 682



BTZ60030

Description :
 Brake Bracket Volvo(L/H)

Application :
 Meritor(Ø410),VOLVO FH12

OEM No :
 3092466, 681 92 681



BTZ60031

Description :
 Brake Pinion Repair Kit (Left)

| No | BT No | Information |
|----|---------------|---------------------|
| 1 | BTT265 x 1 | Pinion (Left) |
| 2 | BTT261 x 1 | Pin |
| 3 | BTK94 x 1 | O-Ring |
| 4 | BTK93 x 1 | O-Ring |
| 5 | BTS143-01 x 1 | Locking Shim (Left) |
| 6 | BTY29 x 1 | Locking Spring |

Application :
 VOLVO F10,MAN,RENAULT

OEM No :
 SP8548, 272906, 5021 203 714, 1322422,
 N2509996031

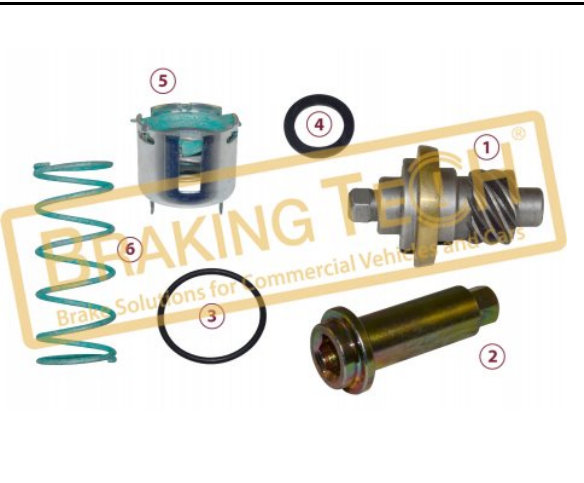

BTZ60032

Description :
 Brake Pinion Repair Kit (Right)

Application : :
 VOLVO F10,MAN,RENAULT

OEM No :
 SP8549, 272907, 1322439, N2509996033

| No | BT No | Information |
|----|------------|----------------------|
| 1 | BTT264 x 1 | Pinion (Right) |
| 2 | BTT261 x 1 | Pin |
| 3 | BTK94 x 1 | O-Ring |
| 4 | BTK93 x 1 | O-Ring |
| 5 | BTS143 x 1 | Locking Shim (Right) |
| 6 | BTY30 x 1 | Locking Spring |

BRAKING TECH®

Brake Solutions for Commercial Vehicles and Cars

www.brakingtech.com

www.serinfren.com

[f /BrakingTech](#)

[s /SerinoTomotiv.Oğuz](#)

[v /Oğuz Serin](#)

[i /brakingtech](#)

[in /BrakingTech-Serin Otomotiv](#)



Kemalpaşa Mah. 7105 Sokak No:4 35060 Pınarbaşı
Bornova / İzmir / TURKEY

export@brakingtech.com

[+90 232 478 5657](tel:+902324785657)

[+90 232 478 5658](tel:+902324785658)